

POČTY OPOTŘEBITELNÝCH NÁHRADNÍCH DÍLŮ

SWIFTER		SE 8000	SE 10000	SE 12000	SM 14000	SM 16000	SM 18000
Radlička kypříče stop	ks	4	4	4	4	4	4
Radlička kypříče stop (stroj vybaven teleskopickým kypříčem)	ks	8	8	8	8	8	8
Radlička	ks	32	40	48	56	64	72
Gamma hrot	ks	80	96	113	136	152	168
SB-radlička	ks	63	76	88	108	118	132
Lopatka Crushbar	ks	27	33	41	53	101	64

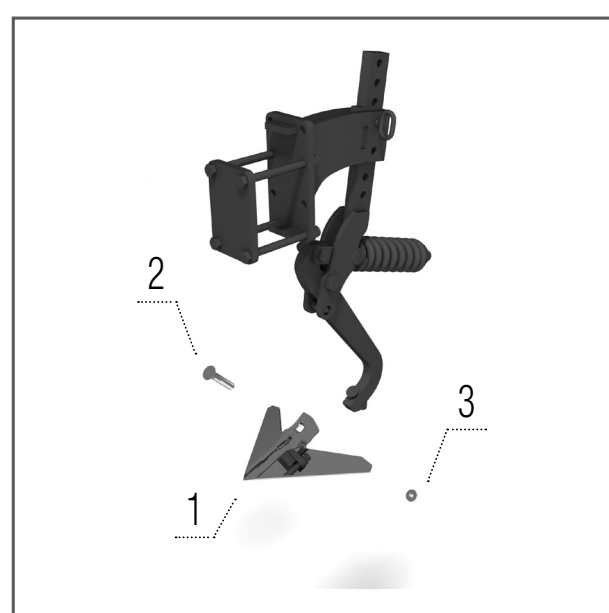

Radlička kypříče stop

Modely SE, SM

- 1 – KM060086 RADLIČKA 1 ks
- 2 – KM000616 ŠROUB 1 ks
- 3 – KM000296 MATICE 1 ks

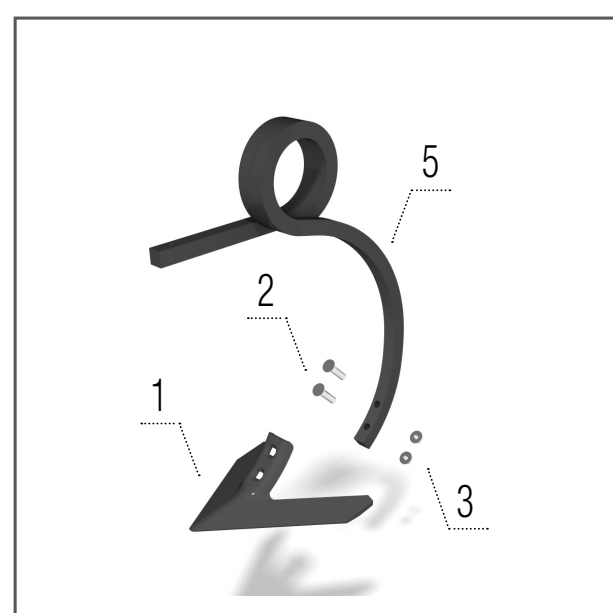

Radlička – pravá

Modely SE, SM

- 1 – KM060173 RADLIČKA 1 ks
- 2 – KM000903 ŠROUB 2 ks
- 3 – KM000296 MATICE 2 ks
- 5 – KM060083 SLUPICE 1 ks

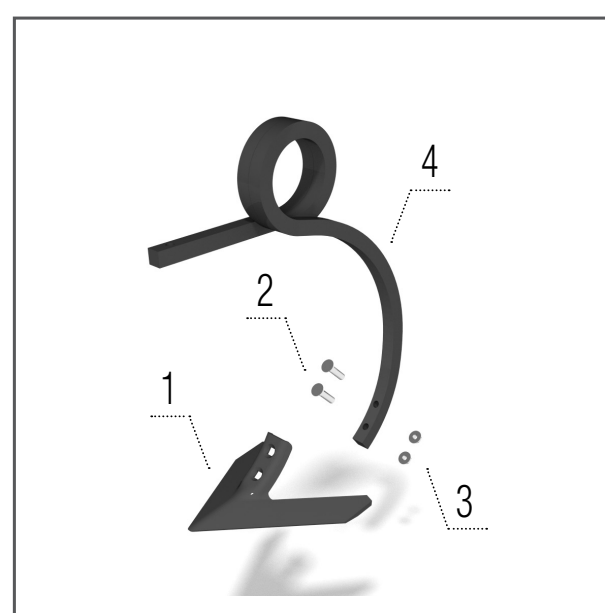

Radlička – levá

Modely SE, SM

- 1 – KM060173 RADLIČKA 1 ks
- 2 – KM000903 ŠROUB 2 ks
- 3 – KM000296 MATICE 2 ks
- 4 – KM060084 SLUPICE 1 ks

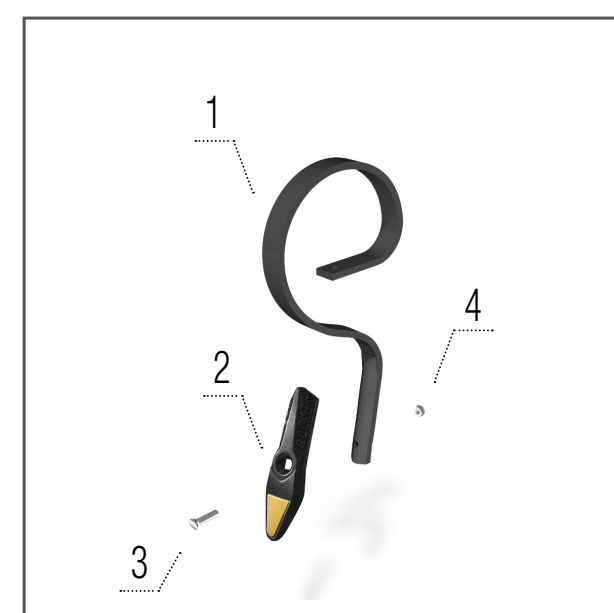

Gamma hrot Long Life

Modely SE, SM

- 1 – 00016973 SLUPICE 1 ks
- 2 – KM060416 DLÁTO 1 ks
- 3 – KM000221 ŠROUB 1 ks
- 4 – KM000096 MATICE 1 ks

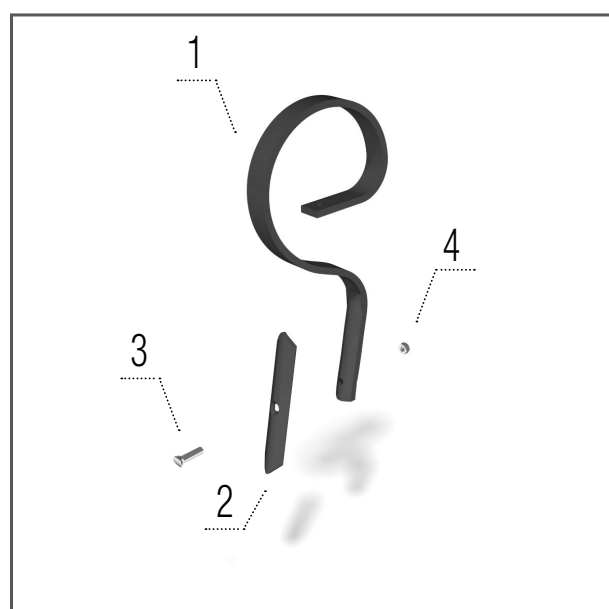

Gamma hrot

Modely SE, SM

- 1 – 00016973 SLUPICE 1 ks
- 2 – KM060142 DLÁTO 1 ks
- 3 – KM000221 ŠROUB 1 ks
- 4 – KM000096 MATICE 1 ks

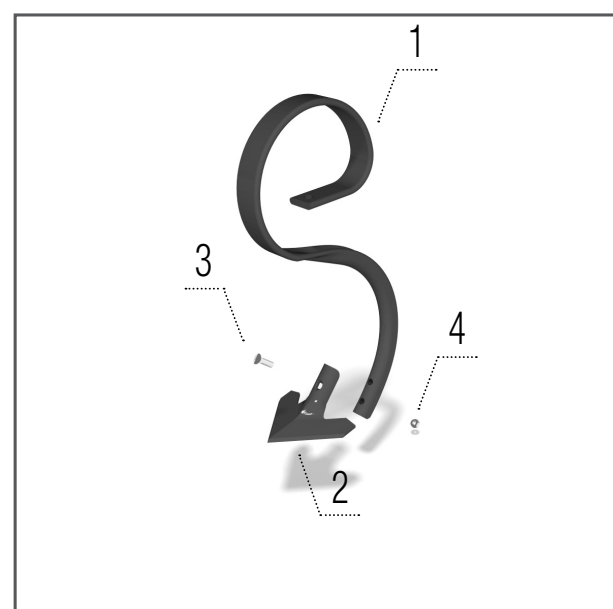

SB-radlička

Modely SE, SM

- 1 – KM060254 SLUPICE 1 ks
- 2 – KM060288 RADLIČKA 1 ks
- 3 – KM000868 ŠROUB 1 ks
- 4 – KM000848 MATICE 1 ks

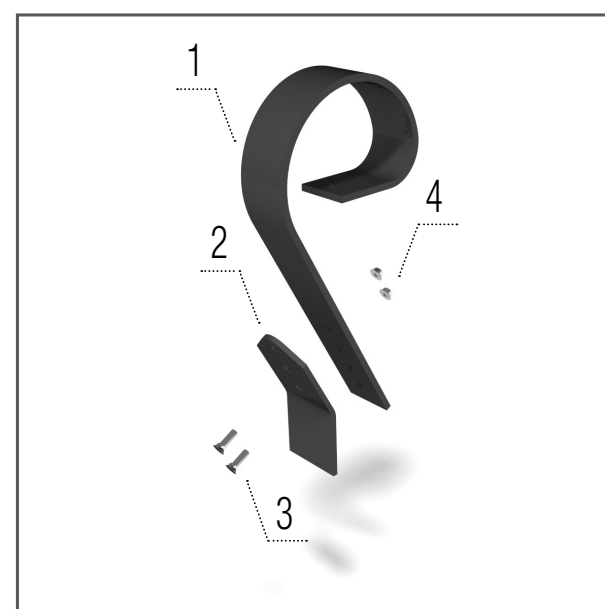

Lopatka Crushbar

Modely SE, SM

- 1 – KM060349 SLUPICE 1 ks
- 2 – KM060369 PLECH 1 ks
- 3 – KM000851 ŠROUB 2 ks
- 4 – KM000848 MATICE 2 ks